

ROVER



Mile End | Office Furniture



"love your work!"

107 Henley Beach Rd. Mile End
mileendofficefurniture.com.au
+618 8229 7676
sales@officefurniture.net.au

ROVER ORIGINAL



Features



Back shell design breathes like mesh.



The base tray provides approximate 35 liters space for personal belongings.



Plastic seat shell comes in 3 colour options and require less maintenance.



Foldable A4 size writing tablet with Anti-Panic mechanism is tested to 50kg loads.

The Modern Classroom

Rover is the tool that will cross boundaries of “immobile” classrooms, enabling educators to provide a modern and effective arena for learning. Rover is designed to be mobile and adaptable in limited spaces and dense classrooms. A room can be transformed from theatre setting to a U-shaped setting effortlessly by moving the chairs around. This allows for maximum utilisation of space as well as increasing interaction between student and teacher.

ROVER 2



Features



Back shell design breathes like mesh.



The base tray provides approximate 30 liters space for personal belongings. Pockets on both side for drinks bottles etc.

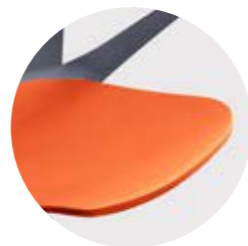

Plastic seat shell comes in 3 colour options and require less maintenance.



A3 size tablet, 360° swingable on its support arm. Slot for tablet or mobile devices.

Seat Shell

Injection-moulded polypropylene shell in choice of 3 colours (100% recyclable).

Optional Seat Upholstery Upholstered over polyurethane cut foam (recyclable into carpet padding, wadding etc).

Chair Shell

Injection-moulded polypropylene shell in white or grey (100% recyclable).

Tablet

Model: BC Writing tablet uses an anti-panic mechanism and is tested to 50kg loads. Its generous size accommodates an open A4 book or 15” notebook computer. Recessions for a pen and cup.

Tablet

Model: BD A3 size tablet can swing 360° on its support arm for left or right handed arounded seat. Slot for tablet or mobile devices.

Base

AR Square Base Moulded polypropylene base in standard grey colour equipped with 50mm dual-wheel castors.

Base

AP Tri-pod Base 600mm diameter storage base of grey moulded polypropylene equipped with 50mm dual-wheel castors.



PP Seat

Padded Seat

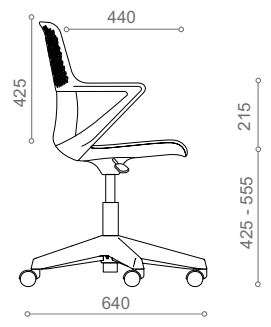
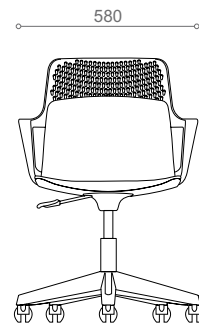
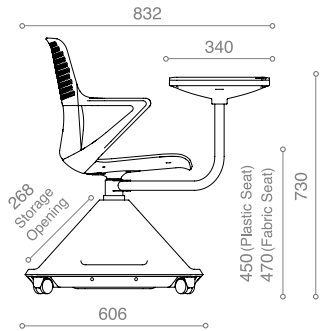
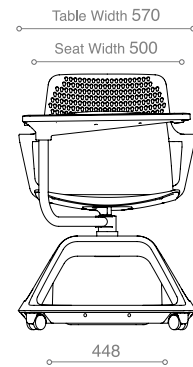
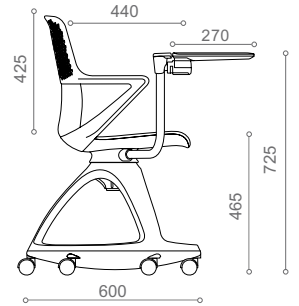
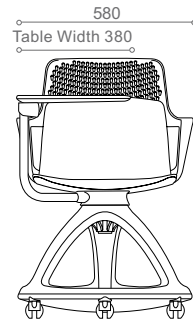

Rover: Option

PP Seat Colour

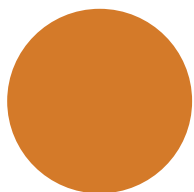

Mango

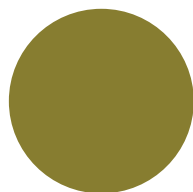

Olive

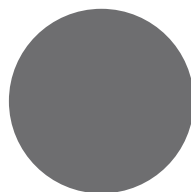

Charcoal

Seat pad upholstery colours available upon request